

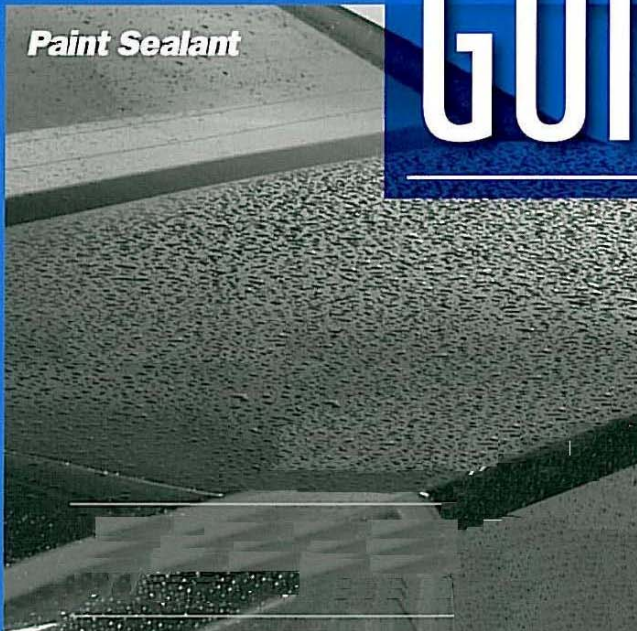

# GENERAL APPLICATION GUIDE

*Paint Sealant*



*Rust Inhibitor*

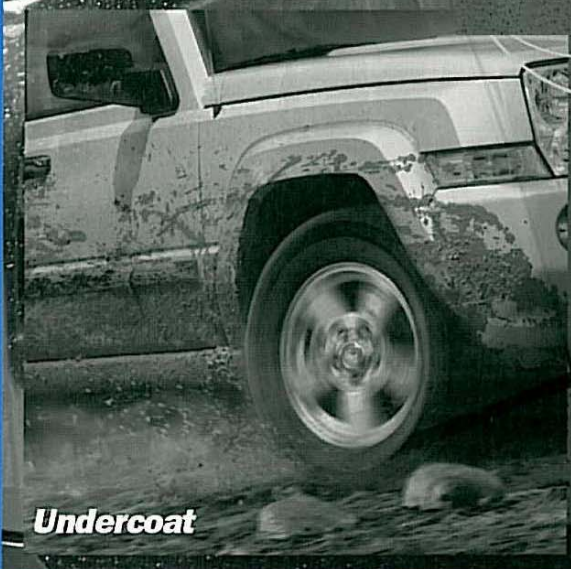
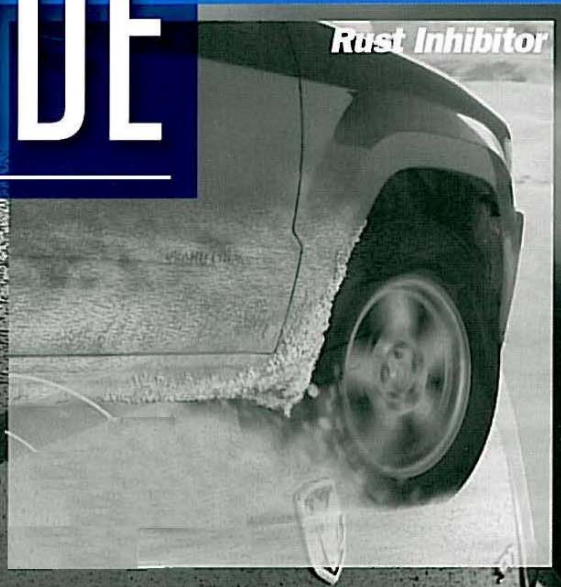

*Undercoat*



*Fabric Protector  
Leather & Vinyl Protectant*

Retail Price: \$13.95

# *Table of Contents*

## **Product Descriptions & General Application Instructions**

Paint Sealant.....	3
Leather & Vinyl Protector.....	4
Fabric Protector.....	5
Undercoating.....	6
Rust Inhibitor.....	7

## **Rust Inhibitor Application Instructions**

Passenger Car.....	8 - 10
Minivan.....	11 - 12
Truck.....	13 - 14
SUV's/Crossovers.....	15 - 18
Large Vans.....	19 - 21



# Paint Sealant



## Application

### ValuGard Paint Sealant Part Number VG-102

#### PRODUCT

- Unique blend of synthetic polymers bonds to paint to form a tough, deep gloss protective seal.
- Advanced formulation prevents oxidation of paint finish while enhancing depth of gloss.

#### APPLICATION

- Application is an easy, one-step process requiring approximately 1/2 hour per vehicle. Removal time is not critical and may be performed hours after application.
- Be sure paint surface is clean and dry. It is recommended to perform the \*ValuGard "A-B-C System" before applying Paint Sealant. Using the orbital polisher or D/A polisher, apply a film of paint sealant evenly over the entire surface with normal pressure. Use approximately 2/3 of the bottle on horizontal surfaces.
- Allow paint sealant to dry thoroughly for 15-20 minutes (or until chalk haze forms), then remove with orbital polisher or two (2) clean soft towels.
- Wipes away easily, leaving a durable, highly lustrous protective finish.
- No consumer reapplication of product is required. Waxing and polishing are eliminated so the only consumer maintenance required is vehicle washing.
- Packaged in 4 ounce bottles, sufficient for one vehicle application. Twelve bottles per case. Also available: Five gallon pail.

#### PAINT SEALANT REAPPLICATION

For painted surfaces that have been damaged and require repainting, the following procedure is recommended:

- After the damaged area has been repainted, allow three to four weeks for curing.
- Reapply Paint Sealant as directed above.

\* For more information on the ValuGard "A-B-C System" please visit our web site [www.automint.com](http://www.automint.com).

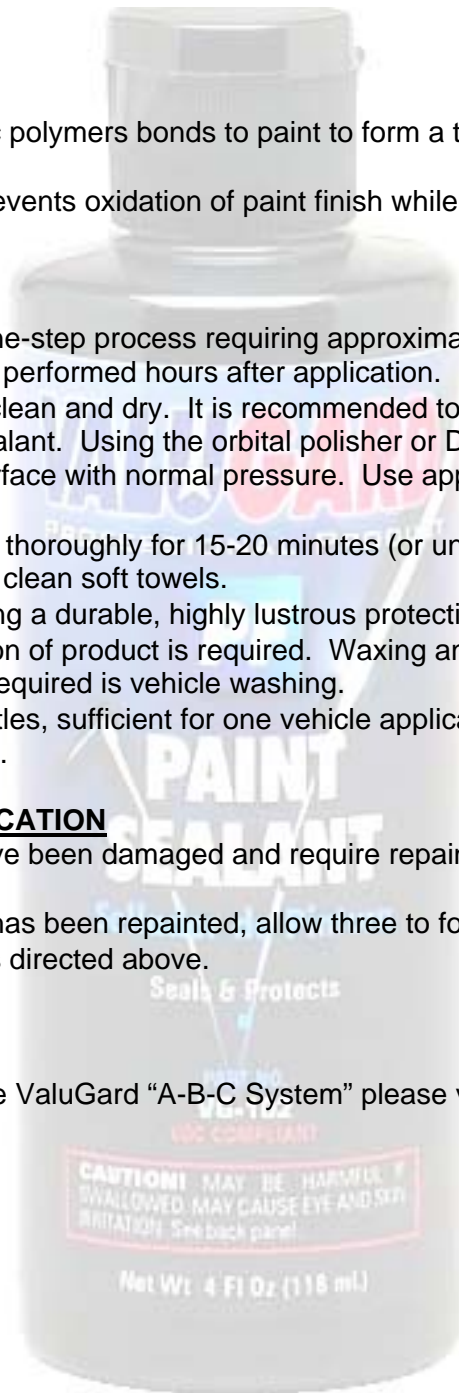

# Leather & Vinyl Protector

## Application

### ValuGard Leather & Vinyl Protector Part Number VG-105

#### PRODUCT

- A special formulation that bonds to the leather or vinyl of the vehicle's interior to give it spill-proof protection.
- Makes vehicle's interior soil-repellent and waterproof. Liquid spills will "bead up" on your leather or vinyl for easy wipe-off or sponging, without dulling your vehicle's interior colors or leaving stains.

#### APPLICATION

- Shake bottle well before applying to leather or vinyl.
- Use product full strength. Do not dilute.
- Be sure leather or vinyl surface is clean and dry. All silicone type dressings must be removed.
- For use only on vinyl and leather; do not use on plastic, painted or chromed surfaces.
- Do not apply to hot surfaces or in direct sunlight.
- Two (2) thin coats are better than one (1) heavy coat.
- Apply with a clean, dry, closed cell sponge; apply small amount to the sponge and wipe evenly on leather or vinyl surface.
- Allow leather & vinyl protectant to dry for 5-10 minutes.
- Packaged in 4-oz. bottles, sufficient for 1 large vehicle application. Twelve bottles per case. Also available: Five gallon pail.



# Fabric Protector



## Application

### ValuGard Fabric Protector Part Number VG-103

#### PRODUCT

- Exclusive formula penetrates upholstery to form a soil-resistant coating around each fiber.
- Long-lasting treatment makes spills clean easily. To clean, wipe away residue with a damp cloth, then simply blot away spills with an absorbent cloth or sponge.
- When cured, solvent-resin formula is odorless, invisible, non-toxic and soil resistant. Provides superior protection over water-based products.
- Not just a surface coating --- offers better multiple spill performance.

#### APPLICATION

- Application is quick and easy using the pressurized spray applicator. Each application takes approximately ½ hour.
- Pour product into pressurized spray applicator (VG-117) and pressurize to 60-100 psi.
- Use entire contents of one 16-oz. container for each vehicle. Apply to all fabric door paneling surfaces, seats, and headliner. Do not use on leather upholstery.
- Beginning with headliner, hold jet sprayer approximately 8-12 inches away from surface to be sprayed. Spray evenly, just enough to wet surface. Continue by spraying on all fabric seating surfaces, seat backs, door panels, then carpet. Remaining product should be sprayed on to seat bottoms to ensure proper coating and then onto floor mats.
- Remove overspray from all non fabric surfaces immediately with soft clean towel.
- Solvent-resin formula is odorless, invisible, non-toxic when cured. Provides superior protection over water-based products.
- Make sure all surfaces are treated properly as per directions.
- Drying time is approximately 1 ½ hours. Optimum protection occurs 24 to 48 hours after application.
- Packaged in 16-oz. bottles, sufficient for one vehicle application. Twelve bottles per case. Also available: Five gallon pail.

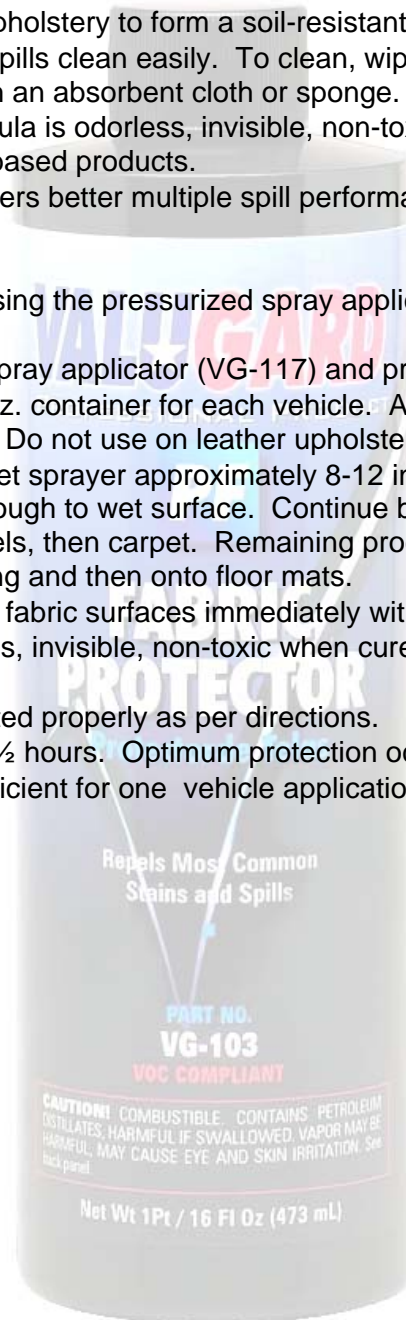

# Undercoating

## Application

### ValuGard Undercoating Part Number VG-104

#### PRODUCT

- Unique product formula maximizes coverage and minimizes overspray and cleanup mess.
- Low odor, wax-based formula contains special additives for superior adhesion and resiliency.
- Compatible with vehicle materials and factory-applied coatings (some competitive undercoating processes will actually damage original equipment coating).
- Compatible with ValuGard Rust Inhibitor.

#### APPLICATION

- Application is quick and easy using the unique dispensing gun. Takes approximately ½ hour per vehicle.
- Bottle attaches directly to the dispensing gun (VG-118 or VG-UCG). No filling mess. When job is completed, simply detach container and discard.
- This wax-based product should be stored at room temperature (at or above 68°F) to avoid an irregular spray pattern. If the product has been left in a cold environment, allow product to come to room temperature. This will enable you to have an even flow of product coming out of your spray gun nozzle.
- For best results, spray the Undercoat material at 80-90 p.s.i.
- Surface should be reasonably dry, free of any dirt, oil or grease before applying product.
- Apply in short even burst to all wheel wells and underbody sheet metal. Do not apply to any exhaust parts, engine, transmission, drive shaft, rear differential, brake backup plates or rotors.
- The average vehicle will require the use of one bottle of product.
- If spray accidentally touches the exterior painted surface of the vehicle, use a mild solvent (mineral spirits), or New Car Prep (VG-N122) or Bug N' Tar Removal (VG-BTR). Wash unit after cleaning and let stand for approximately 30 minutes. NOTE: Avoid high pressure water spray cleaning to treated underbody area for 24 hours.
- Packaged in 31-oz bottles, sufficient for one vehicle application. Twelve bottles per case. Also available: Sixteen gallon kegs and Fifty-five gallon drums.

A Waterbased Undercoating is also available please call for details.

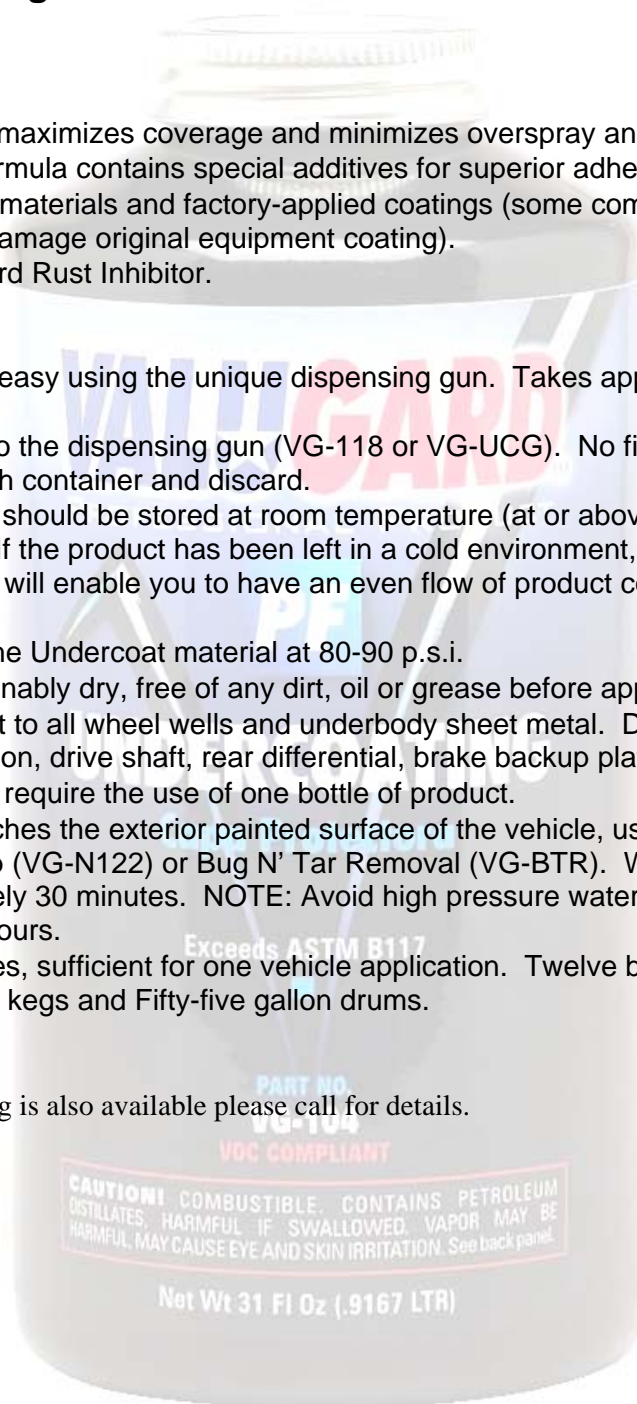



## Instructions

### ValuGard Rust Inhibitor Part Number VG-101

#### PRODUCT

- Product uses a wax-based carrier with rust inhibitors. Eliminates mess, odor, and need for a separate installation area.
- Fogging method penetrates hard-to-reach cracks and crevices to provide maximum protection from inside-out rust-through on doors and other exterior body side panels.
- Drilling product application holes (required with other products) breaks the production paint finish and promotes corrosion. ValuGard Rust Inhibitor requires no drilling and eliminates this risky and time-consuming process.

#### APPLICATION

##### **CAUTION: Roll up all windows before applying Rust Inhibitor.**

- High-quality application equipment is easy to use (VG-107). Application time is approximately ½ hour per vehicle.
- This wax-based product should be thoroughly stirred or shaken in the bottle prior to using. **NOTE: Store product at 68°F or above to avoid a thickening of material which will result in an irregular spray pattern.**
- For best results during application, vehicle should be at room temperature (50°- 75°F)
- Spray gun pressure should be 70-75 p.s.i. when using the short hook wand. Spray gun pressure should be 90-95 p.s.i. when using the long flexible wand.
- You have been supplied with two applicator wands. The long flexible wand automatically sprays in all directions in the access holes where it is used. The short hook wand sprays in a single direction, so you must rotate the short wand spray head to ensure complete coverage.
- In areas where the long flexible wand is used, push the wand as far as it can go into the access hole. Pull the trigger of the gun. To ensure even coverage, wait 2-3 seconds before you slowly start pulling the wand out of the access hole.
- The short hook wand should be directed toward the outer body panels in a rotating manner. Depress the trigger of the gun for approximately 3-5 seconds. This will generate a dense fog for maximum film-building corrosion protection.
- In the few areas where the long flexible wand is too large to enter an access hole, use the short hook wand.
- After Rust Inhibitor application is complete, clean any overspray with a mild solvent such as mineral spirits or New Car Prep (VG-N122) or Bug N' Tar Removal (VG-BTR). Wash the vehicle immediately afterward.
- Packaged in 31-oz. bottles, sufficient for one vehicle application. Twelve bottles per case. Also available: Sixteen gallon kegs and Fifty-five gallon drums.
- The entire contents of the bottle should be used for average size vehicle.

The following pages contain guidelines for several vehicle types to help you identify critical application areas.

# Rust Inhibitor

## PASSENGER CAR APPLICATION

### HOOD PANEL

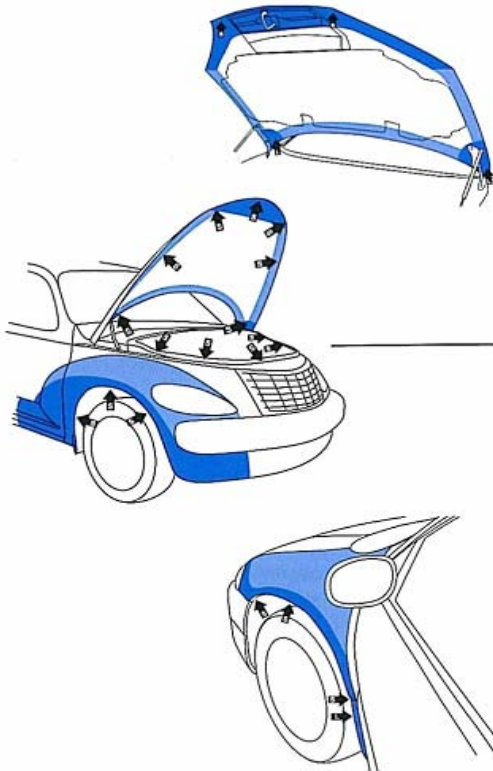

- Remove rubber grommets (if necessary) to insert short wand in all outer perimeter application holes.
- Point the short wand toward the outer perimeter of the vehicle for heaviest application. Rotate wand to concentrate on outer perimeter areas.
- Be sure to replace any rubber grommets removed during the application process.
- Use the long flexible wand in the small holes in each interior lower corner of the hood.

### FRONT FENDER

- Open door for access into interior of front fender. See picture below.
- For access into lower section of front fender, use the short hook wand. Use the long wand to reach upper portion of the interior front fender.
- Be sure to thoroughly spray all internal surfaces of fender. Critical area is the lower portion of inside front fender. Use lower drain slot to thoroughly coat this area.

### DOORS

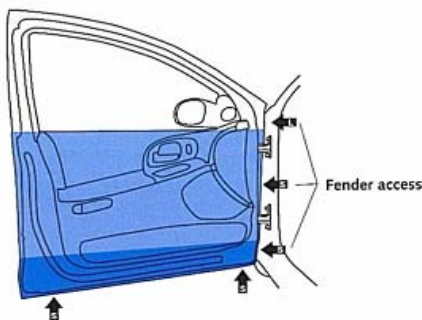

- Insert the short wand into drain holes.
- Spray in an upward and outward direction, coating the entire outer door skin.
- **IMPORTANT** -- Be sure to thoroughly coat the bottom and lower inside corners of each door, both inside the cavity and on the seam.

### Shaded Areas:

Light blue: Standard application

Dark Blue: Heavier application



# Rust Inhibitor



## PASSENGER CAR APPLICATION

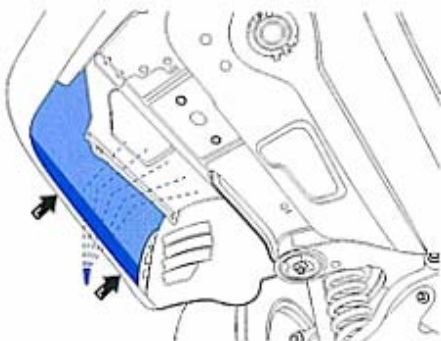
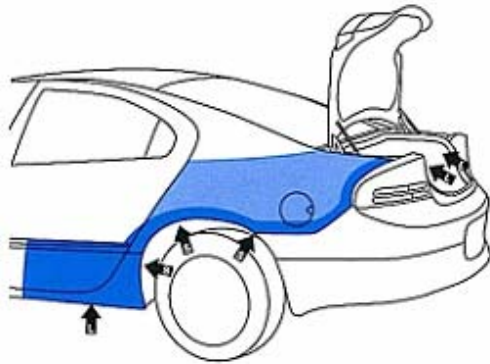
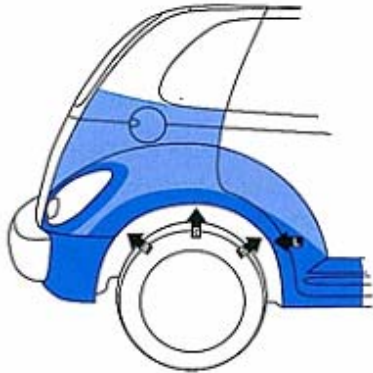

### REAR QUARTER PANEL

- The interior of the rear quarter panel can be reached from the inside of the trunk. Remove trunk trim and insert long flexible wand up into the rear quarter panel.
- Use wand to cover entire surface of interior rear quarter panel. Use both the long and short wands for complete coverage.
- Insert long wand into access hole on rocker panel.
- On some vehicles remove vent cover from dog leg. Use long wand to spray into quarter panel and dog leg.
- On some vehicles remove carpeted access panels in the interior wall of the cargo storage area.
- Insert long wand toward the front of the vehicle.
- Begin spraying as you slowly withdraw the long wand.
- **IMPORTANT** -- Be sure to thoroughly coat the bottom 1/3 of the quarter panel.

Arrows marked with "S" indicate that the short wand should be used.  
Arrows marked with "L" indicate that the long wand should be used.

# Rust Inhibitor

## PASSENGER CAR APPLICATION

### DECKLID

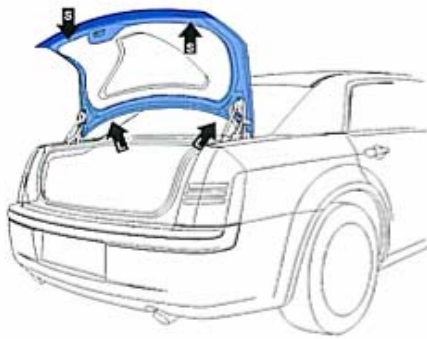

- Insert the short hook wand and spray in each reinforcement rib of outer perimeter of decklid panel.
- Insert the long flexible wand in the small holes in each lower corner of decklid. Coat thoroughly.
- On some vehicles insert short wand through the four openings on the bottom edge of the hatch.
- Important: Be sure to rotate the spray nozzle 360 degrees while spraying through each opening.
- On some vehicles remove access plugs outboard of courtesy lights at bottom of hatch.
- Insert short wand; rotate wand 360 degrees while spraying through each access hole.
- **IMPORTANT** -- Be sure to thoroughly coat the bottom edge of the hatch, including the corners.

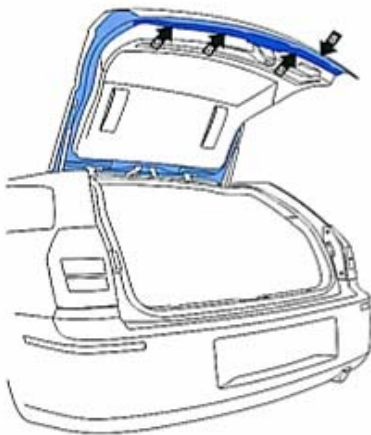

### ROCKER PANEL

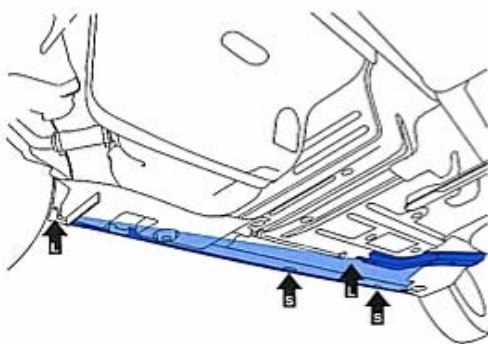

- Insert long wand into opening at rear rocker panel at wheel house opening.
- Use short wand to spray through forward drain holes.
- On some vehicles spray between cladding and rocker panel.

# Rust Inhibitor



## MINIVAN APPLICATION

### HOOD PANEL

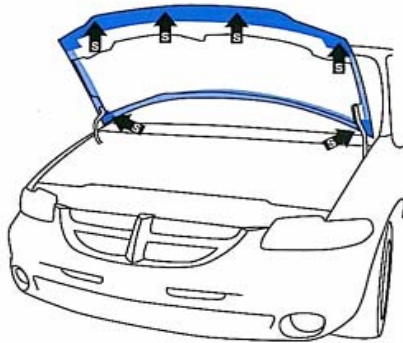

- Remove rubber grommets (if necessary) to insert short wand into all outer perimeter application holes.
- Point the short wand toward the outer perimeter of the vehicle for heaviest application. Rotate wand to concentrate on outer perimeter areas.
- Be sure to replace any rubber grommets removed during the application process.
- Use the short hook wand in the small holes in each interior corner of the hood.

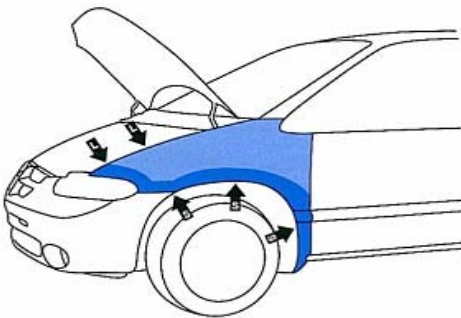

### FRONT FENDER

- Open hood for access into interior of front fender.
- Use the long flexible wand for access into the upper and lower portions of the inside front fender.
- Be sure to thoroughly spray all internal surfaces of fender. Critical area is lower portion of inside front fender. Use lower drain slot to thoroughly coat this area.

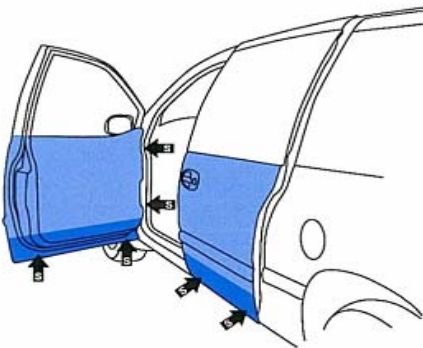

### DOORS

- Use the short wand for all access points. Insert wand into drain holes of front passenger and rear sliding doors.
- Spray in an upward and outward direction. Rotate the wand 180 degrees to coat the entire outer door skin.
- **IMPORTANT** -- Be sure to thoroughly coat the bottom and lower inside corners of each door, both inside the cavity and on the seam.



# Rust Inhibitor

## MINIVAN APPLICATION

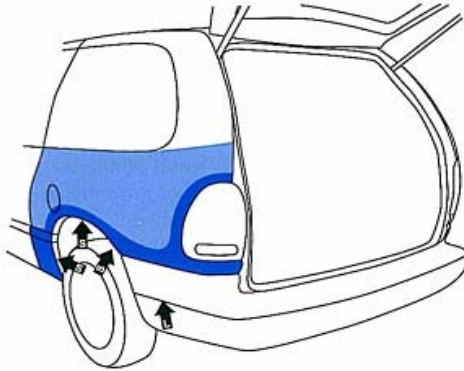

### REAR QUARTER PANEL

- Passenger side may be accessed through jack storage compartment.
- Driver side, use long wand insert at rear of wheel well.

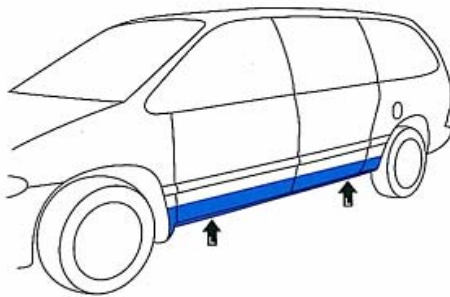

### ROCKER PANEL

- Insert tip of long flexible wand into drain hole under rocker panel. Spray in all directions.

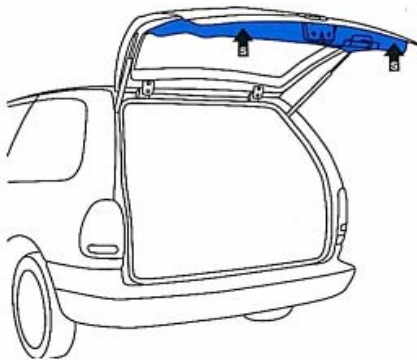

### LIFTGATE

- Insert tip of short hook wand into each corner and into drain holes on outer perimeter of liftgate. Spray in all directions.

# Rust Inhibitor



## TRUCK APPLICATION

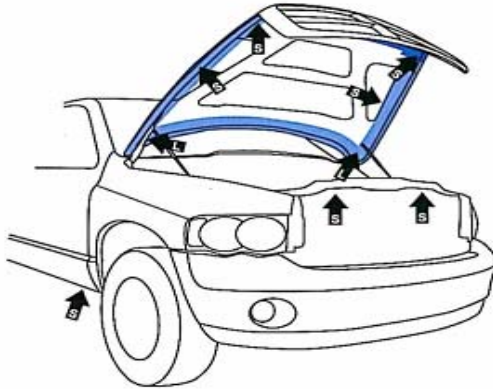

### HOOD PANEL

- Insert short hook wand in all outer perimeter application holes
- Point the short wand toward the outer perimeter of the vehicle for heaviest application. Rotate wand to concentrate on outer perimeter areas.
- Insert the long flexible wand in the small holes in each corner of the hood to get complete coverage on lower perimeter of the hood.

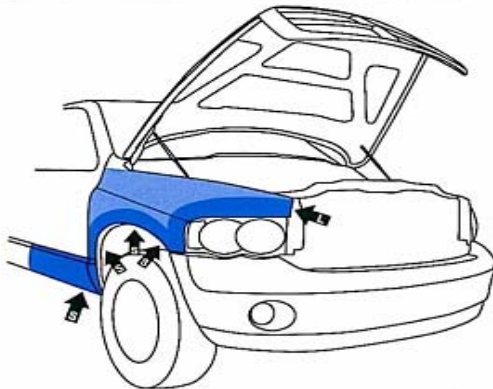

### FRONT FENDER

- Lift hood panel for access into interior of front fender panel. Insert long flexible wand into drain holes on outer perimeter of hood panel.
- Use the long flexible wand for access into upper and lower sections of front fender.
- Be sure to thoroughly spray all internal surfaces. Critical area is the lower portion of inside front fender.

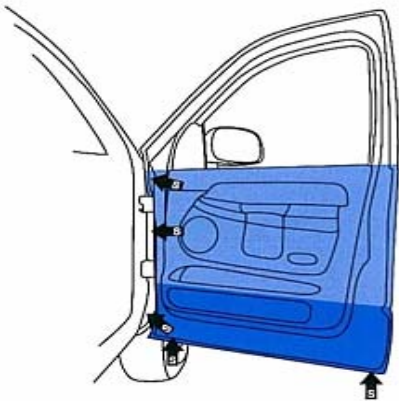

### DOORS

- Insert the short hook wand into the drain holes at the bottom of door panel.
- Spray in an upward and outward direction, coating the entire outer door skin. Rotate wand 180 degrees.
- **IMPORTANT** – Be sure to thoroughly coat the bottom and lower corners of each door.

Arrows marked with "S" indicate that the short wand should be used.  
Arrows marked with "L" indicate that the long wand should be used.

# Rust Inhibitor

## TRUCK APPLICATION

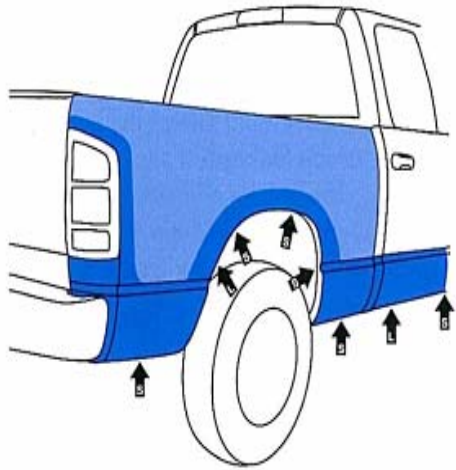

### REAR QUARTER PANEL

- The interior of the rear quarter panel can be accessed from underneath the wheel well. Insert long flexible wand up into rear quarter panel.
- Insert short hook wand into drain holes at bottom of wheel well. Spray in an upward and outward direction.
- Be sure to cover entire surface of inside rear quarter panel, spraying in all directions.
- Use short wand to coat wheel well lip.

### ROCKER PANEL

- Insert long flexible wand in the opening at the bottom rear of the rocker panel.
- When fully inserted, begin spraying and continue spraying as you slowly withdraw the wand.

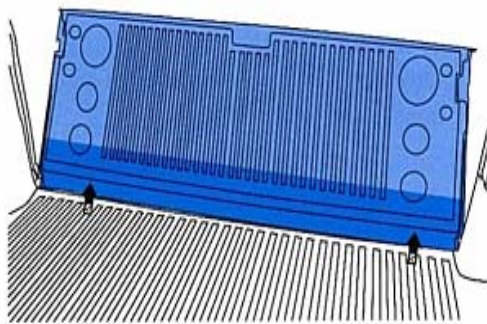

### TAILGATE

- Insert short hook wand through drain holes in the bottom of the gate and through side latches.



# Rust Inhibitor



## SUV'S / CROSSOVER APPLICATION

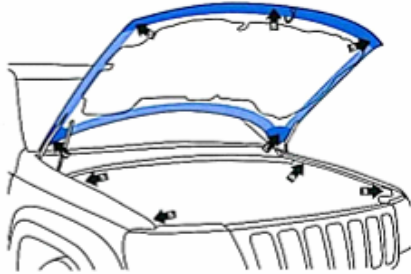

### HOOD PANEL

- Insert long flexible wand in outer perimeter application holes
- Use the short hook wand in the small holes on sides and corners of hood panel.
- Point wand toward outer perimeter of vehicle for heaviest application. Rotate wand to concentrate on outer perimeter areas.
- Using the short wand, overspray the hem flange along the top of the front fender.

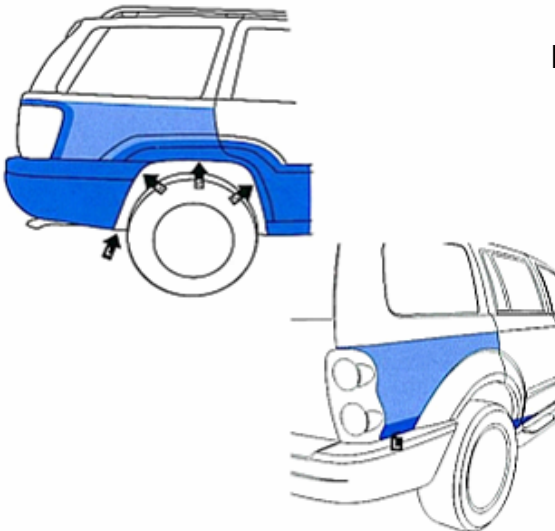

### REAR QUARTER PANEL

- On some vehicles insert long wand at opening at rear of wheel well and spray.
- Use short wand to spray the wheel well hem flange.
- On some vehicles insert long wand between top of bumper fascia and bottom of rear quarter.
- Move the tip of the wand toward the front of the vehicle, then spray.

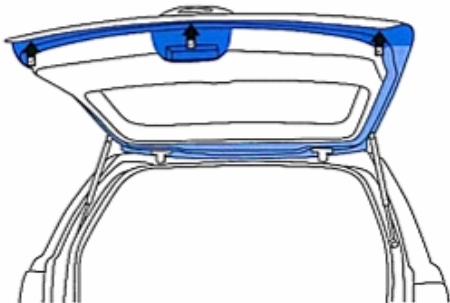

### LIFTGATE

- Insert tip of short hook wand into drain holes on outer perimeter of liftgate. Spray in all directions.

Arrows marked with "S" indicate that the short wand should be used.  
Arrows marked with "L" indicate that the long wand should be used.

# Rust Inhibitor

## SUV'S / CROSSOVER APPLICATION

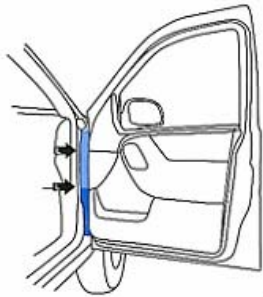

### FRONT FENDER

- Open hood and front doors to access interior of front fenders.
- Insert long flexible wand along outer perimeter of inside fender panels.
- Be sure to thoroughly spray all internal surfaces of fenders. Rotate head of wand 180 degrees to reach all areas. Critical area is the lower portion of inside fender.

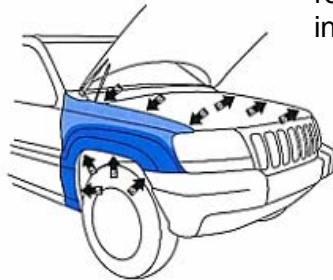

### DOORS

- Use short hook wand for all access points. Insert wand into drain holes above and below door latch.
- Spray in an upward and outward direction, coating the entire outer door skin.
- **IMPORTANT** – Be sure to thoroughly coat the bottom and lower corners of each door.



# Rust Inhibitor



## SUV'S / CROSSOVER APPLICATION

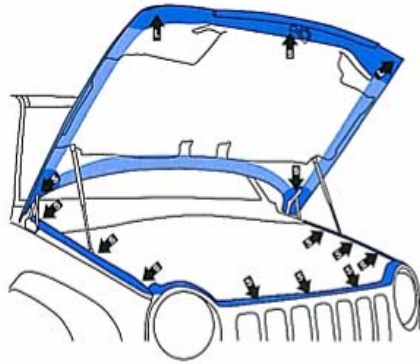

### HOOD PANEL

- Insert long flexible wand in outer perimeter application holes
- Use the short hook wand in the small holes on sides and corners of hood panel.
- Point wand toward outer perimeter of vehicle for heaviest application. Rotate wand to concentrate on outer perimeter areas.

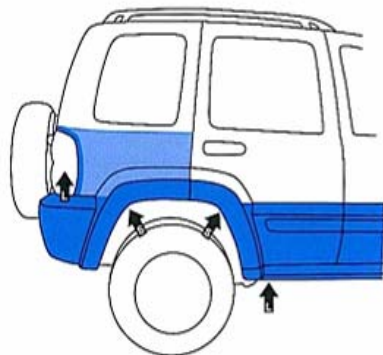

### REAR QUARTER PANEL

- Remove taillights for access into interior of rear quarter panel. Insert long flexible wand to thoroughly cover entire surface.
- Insert long flexible wand over wheel well liner from beneath vehicle.
- Using the short wand, overspray the hem flange in the wheel well.

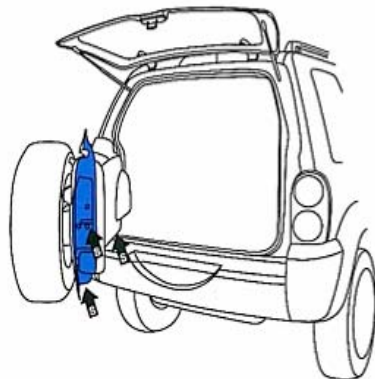

### LIFTGATE

- Insert tip of short hook wand into drain holes on outer perimeter of liftgate. Spray in all directions.

Arrows marked with "S" indicate that the short wand should be used.  
Arrows marked with "L" indicate that the long wand should be used.



# Rust Inhibitor

## SUV'S / CROSSOVER APPLICATION

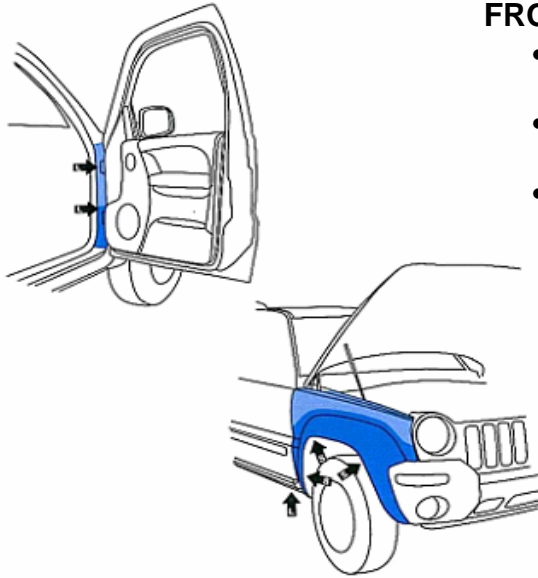

### FRONT FENDER

- Open hood and front doors to access interior of front fenders.
- Insert long flexible wand along outer perimeter of inside fender panels.
- Be sure to thoroughly spray all internal surfaces of fenders with the short wand. Rotate head of wand 180 degrees to reach all areas. Critical area is the lower portion of inside fender.

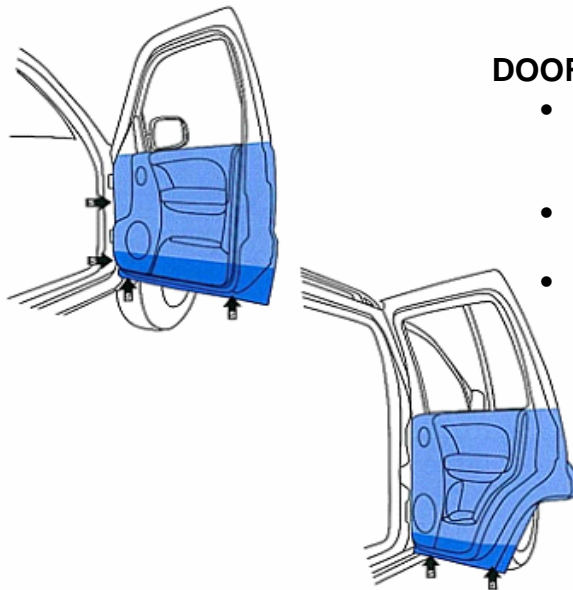

### DOORS

- Use short hook wand for all access points. Insert wand into drain holes above and below door latch.
- Spray in an upward and outward direction, coating the entire outer door skin.
- **IMPORTANT** – Be sure to thoroughly coat the bottom and lower corners of each door.

# Rust Inhibitor



## LARGE VANS APPLICATION

### HOOD

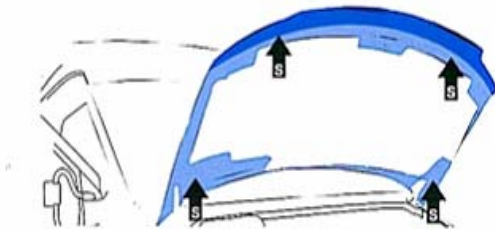

- Insert short wand into drain holes on leading edge and trailing edge of hood panel.
- Rotate wand 360 degrees while spraying.
- **IMPORTANT** – Be sure to thoroughly coat the hem flange or the leading edge of the hood both inside the cavity and on the exterior of the seam.

### FRONT FENDER



- Insert long wand through opening above headlight and spray thoroughly coating the bottom third of the fender.
- Access may also be gained through opening above hood strut or through vent in the fender surface.

### FRONT DOOR

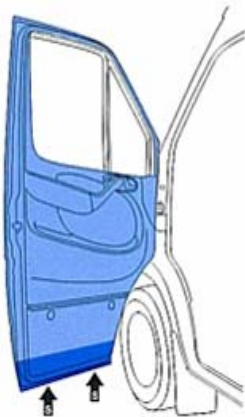

- Insert short wand into drain openings at the bottom of the door.
- Rotate wand 360 degrees while spraying.
- **IMPORTANT** – Be sure to thoroughly coat the bottom third of the door while spraying inside the cavity.
- Remove wand and lightly spray exterior hem flange at the bottom of the door.

Arrows marked with "S" indicate that the short wand should be used.  
Arrows marked with "L" indicate that the long wand should be used.

# Rust Inhibitor

## LARGE VANS APPLICATION

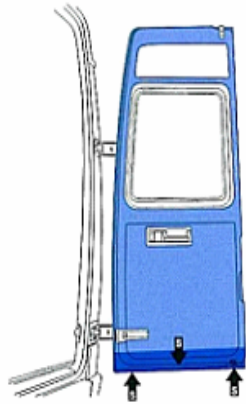

### REAR DOOR

- Insert short wand into drain openings at the bottom of the door.
- Rotate wand 360 degrees while spraying.
- **IMPORTANT** – Be sure to thoroughly coat the bottom third of the door while spraying inside the cavity.
- Remove wand and lightly spray exterior hem flange at the bottom of the door.

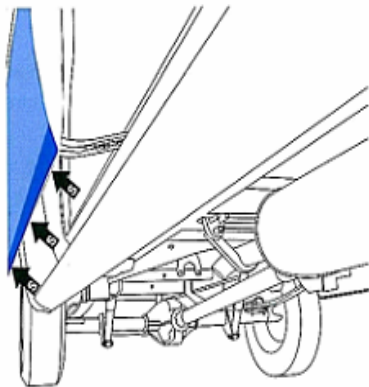

### SLIDING DOOR

- Access is through the drain holes at the bottom of the door, on the inside edge facing the interior.
- Insert short wand into drain openings at the bottom of the door.
- Rotate wand 360 degrees while spraying.
- **IMPORTANT** – Be sure to thoroughly coat the bottom third of the door while spraying inside the cavity.
- Remove wand and lightly spray exterior hem flange at the bottom of the door.

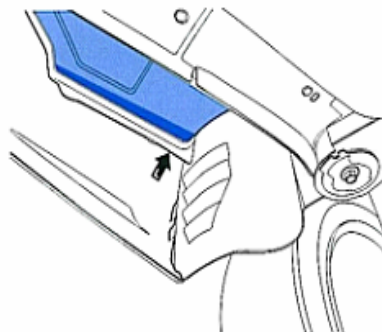

### REAR QUARTER PANEL

- Insert long wand at opening at rear of wheel well liner.
- Thoroughly spray both toward the front and the rear of the vehicle.



# Rust Inhibitor



## LARGE VANS APPLICATION

### REAR QUARTER PANEL

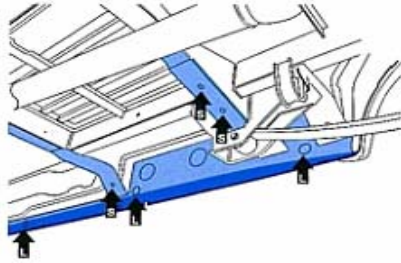

- Insert long wand either through the drain holes or the access plugs along the bottom of the rocker panel.
- Slowly withdraw along length of the rocker panel while spraying.
- **IMPORTANT** – Be sure to thoroughly coat the bottom hem flange of the rocker panel.

### FRAME



- Insert short wand into drain holes of frame rails.
- Rotate spray nozzle 360 degrees while spraying.

### ROCKER PANEL/FRAME

- Treatment must be repeated for the portion of the rocker panel and frame rails at the rear portion of the wheel well opening.
- Insert long wand either through the drain holes or the access plugs along the bottom of the rocker panel.
- Slowly withdraw wand along length of the rocker panel while spraying.
- **IMPORTANT** – Be sure to thoroughly coat the bottom hem flange of the rocker panel.
- Insert short wand into drain holes of frame rails.
- Rotate spray nozzle 360 degrees while spraying.

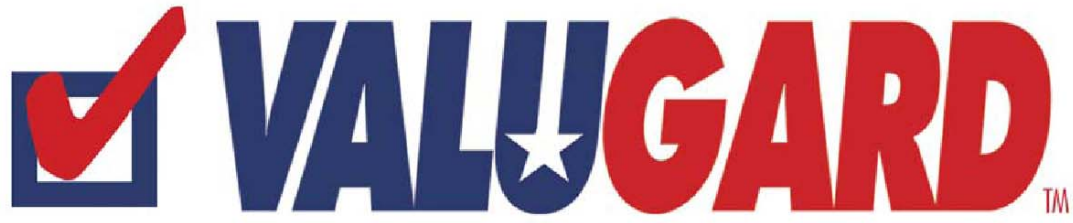

Automotive International, Inc. \* 8855 Blue Ash Road \* Cincinnati, OH 45242  
Phone: 513.489.7883 \* 800.543.7156 \* Fax: 513.489.1329 \* Web Site: [www.valugard.net](http://www.valugard.net)