



GROUP
Campaign

MODEL
2001-2004MY Optima (MS)

NUMBER
SC 075

DATE
June 2009

SAFETY RECALL CAMPAIGN TECHNICAL SERVICE BULLETIN

SUBJECT: REPAIR/REPLACEMENT OF SUBFRAME

This bulletin provides information related to a service campaign for the inspection and related repair, or replacement, if necessary, of the subframe due to corrosion in 2001-2004 Kia Optima vehicles produced from 10/6/2000 ~ 11/19/2003, that are currently registered in the states where heavy amounts of road salt is used. This condition is typically related to a lack of regular cleaning of the vehicle underbody as outlined in the "Underbody Maintenance" section of the vehicle's owner's manual. In rare cases, the corrosion may be sufficient to warrant a replacement of the subframe.

Owners of 2001-2004 Kia Optima vehicles currently registered in the 21 states which are known to use heavy amounts of road salt are being notified to schedule an appointment with the nearest Kia dealer. The 21 states are: CT, DC, DE, IA, IL, IN, MA, MD, ME, MI, MN, MO, NH, NJ, NY, OH, PA, RI, VT, WI, WV. This TSB sets out the procedures to be followed in conducting the inspection and repair, or replacement if necessary, of the vehicle's subframe. The dealer is also to provide instruction to the customer on the proper maintenance of the underbody of the vehicle when exposed to road salt conditions, consistent with the information contained in the "Underbody Maintenance" section in the vehicle's owner's manual.

***NOTICE**

There is no charge to the vehicle owner for this repair. Under applicable law, you may not sell or otherwise deliver any affected 2001-2004MY Optima (MS) until it has been repaired pursuant to the procedures set forth in this bulletin.

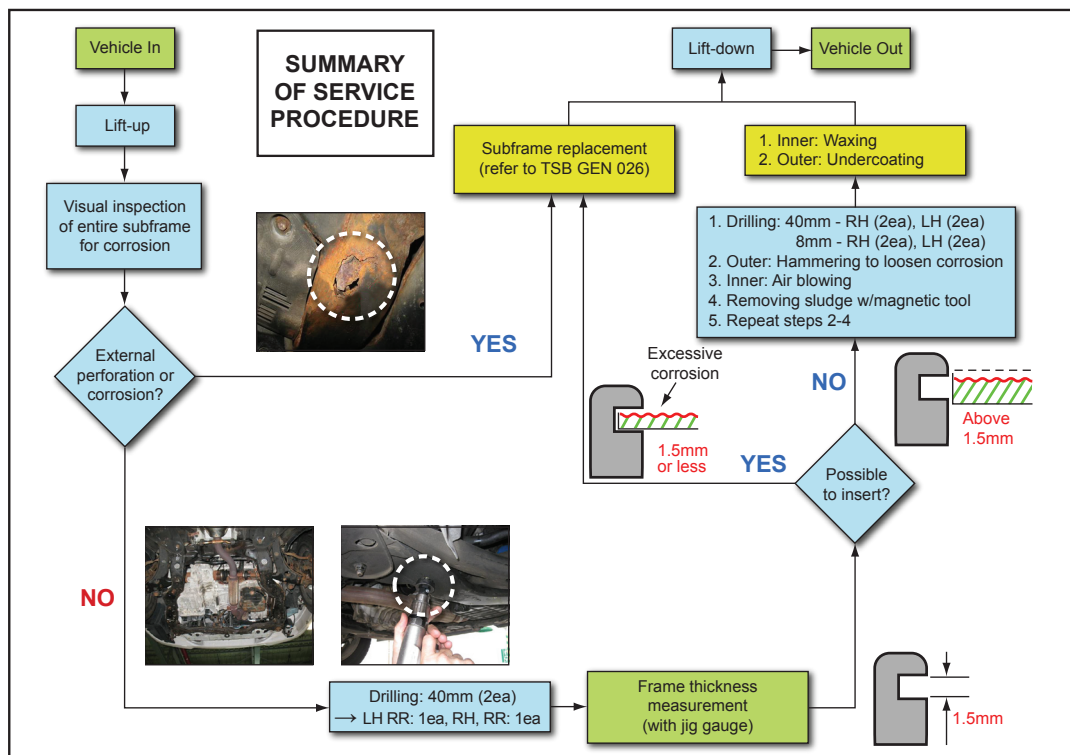

File Under: Campaign

- Circulate To: General Manager Service Manager Parts Manager
 Service Advisor(s) Technician(s) Body Shop Manager Fleet Repair

SUBJECT:

REPAIR/REPLACEMENT OF SUBFRAME

Inspection Procedure:

Open hood and check for SC 075 Campaign completion label on the panel above the master cylinder. If label exists, NO FURTHER ACTION IS REQUIRED.

If label does not exist, continue to step one (1) of the service procedure until completion.



1. Raise the vehicle on a hoist in preparation for the underbody inspection of the subframe.



2. Inspect the entire subframe assembly for any external signs of severe corrosion/perforation.
 - a) If any perforation or open cavity is found in the subframe, do not continue repairing. Replace the subframe according to TSB GEN 026. If no signs of perforation or severe corrosion are found, continue to step (b).
 - b) Using a hammer, lightly tap the entire subframe in several areas to check for any material which may be nearing the perforation stage. If the hammer opens up a cavity in the subframe, replace the subframe according to TSB GEN 026.



*NOTICE

Make sure to inspect for any corrosion cavity throughout the subframe, including the sides.

SUBJECT:

REPAIR/REPLACEMENT OF SUBFRAME

Service Procedure:

- In preparation for the drilling of the 40 mm hole-saw cuts for the front / rear subframe sites, the following identification procedure must be utilized to ensure the proper drilling location. The 40 mm hole-saw site locations will be numbered as follows: (1-4) / (Large Blue Holes).
- Located on the left-rear of the subframe is drilling site location (One) 1. Using a straight edge ruler, scribe or draw a seventy (70) mm line from the end of the horizontal weld (dashed line).
- Referencing the dashed line, measure thirty (30) mm from the outer horizontal weld (dashed line) and mark this location. From this new reference mark, measure ten (10) mm forward from this position and mark this location as the center point of the drilling. Drill this location using the forty (40) mm hole-saw (Drill speed recommendation: 380 ~ 470 rpm).

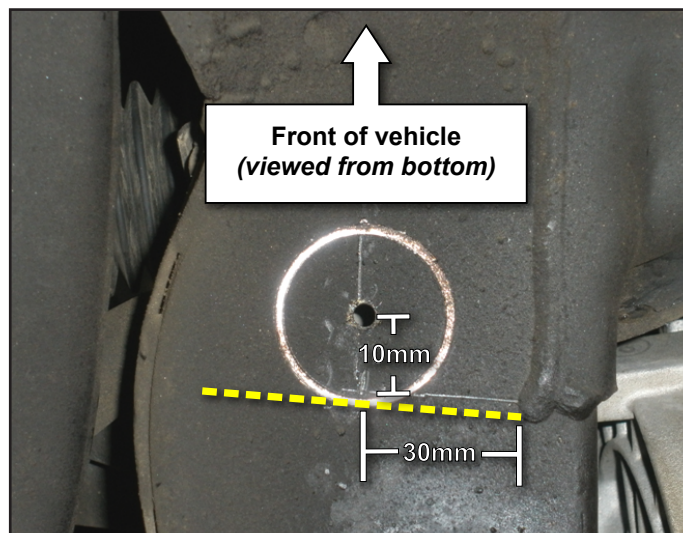
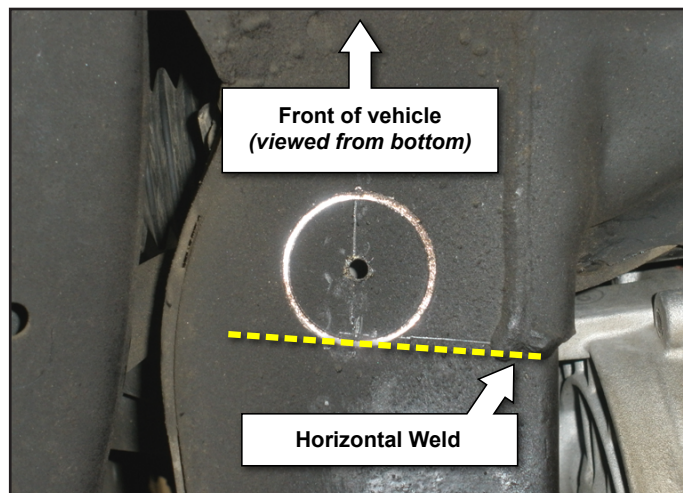
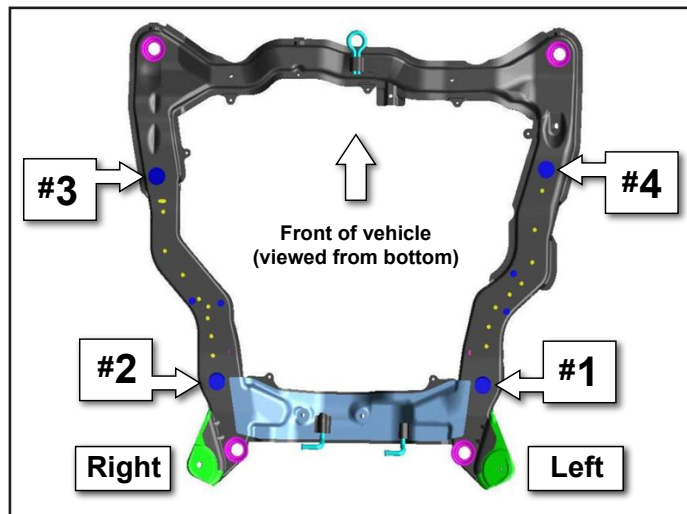
**CAUTION**

Use safety glasses, respirator and gloves when performing any procedure using a drill.

SUBJECT:

REPAIR/REPLACEMENT OF SUBFRAME

- Repeat this same procedure (Step 4 & 5) for location Two (2) drill site on the right-rear side of the subframe. Drill this location using the 40 mm hole-saw (Drill speed recommendation: 380 ~ 470 rpm).

CAUTION

Use safety glasses, respirator and gloves when performing any procedure using a drill.



- Debur the holes on both sides in several areas around the edges of the 40 mm hole so that an accurate judgment of the subframe material thickness can be made.



WARNING

Failure to perform this deburring step may cause a false “pass” on the subframe condition in the following step.

If the metal burrs are left around the hole, they may block the thickness gauge and indicate that the subframe is thicker than it actually is.

SUBJECT:

REPAIR/REPLACEMENT OF SUBFRAME

6. Referencing the 1.5 mm side (smallest width) of the thickness gauge, attempt to slide the thickness gauge over the edge of the hole in several different locations on both left/right rear inspection sites.

***NOTICE**

Ensure that the 1.5mm gauge (smallest width) is used for this test of subframe thickness. Failure to use the correct (1.5mm) gauge will result in unnecessary replacement of subframe.

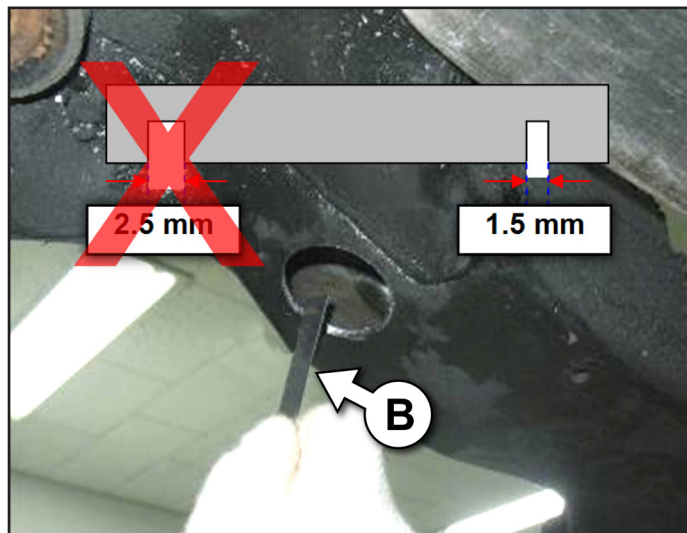

- a) If the thickness gauge (B) is able to pass over the subframe material, it has failed the 1.5 mm minimum thickness test. Replace the subframe according to TSB GEN 026.
- b) If the gauge will not pass over the subframe material, the corrosion preventive treatment can be performed. Proceed to the next step.

- 7a. In preparation for drilling the 40 mm hole-saw site three (3) in the right front, the following method must be used to insure proper drilling location. Locate the center point of the right side subframe bushing bolt, use a straight edge to draw a horizontal line for 19 mm inboard. From the end of the 19 mm horizontal line, use a straight edge to draw a vertical line for 294 mm. From the end of the 294 mm vertical line, mark this location as the center point for drilling. Drill this location using the 40 mm hole-saw. (Drill Speed Recommendation: 380 ~ 470 rpm).

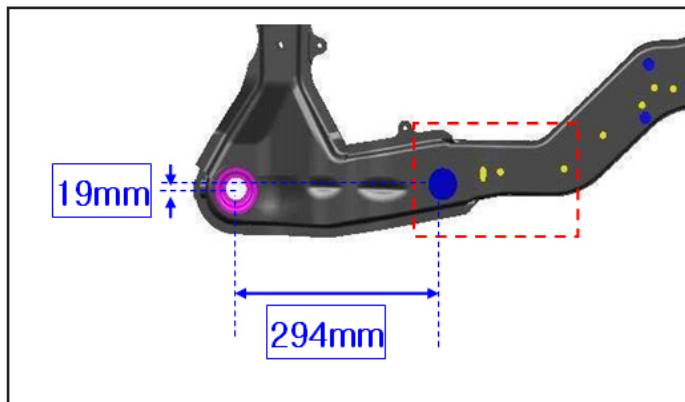

⚠ CAUTION

Use safety glasses, respirator and gloves when performing any procedure using a drill.

SUBJECT:

REPAIR/REPLACEMENT OF SUBFRAME

***NOTICE**

No thickness measurements are required in the forward 40 mm drill sites #3 & #4.

- 7b. In preparation for drilling the 40 mm hole-saw site four (4) in the left front, the following method must be used to insure proper drilling location. Locate the center point of the left side subframe bushing bolt, use a straight edge to draw a horizontal line for 21 mm inboard. From the end of the 21 mm horizontal line, use a straight edge to draw a vertical line for 266 mm. From the end of the 266 mm vertical line, mark this location as the center point for drilling. Drill this location using the 40 mm hole-saw. (Drill Speed Recommendation: 380 ~ 470 rpm).

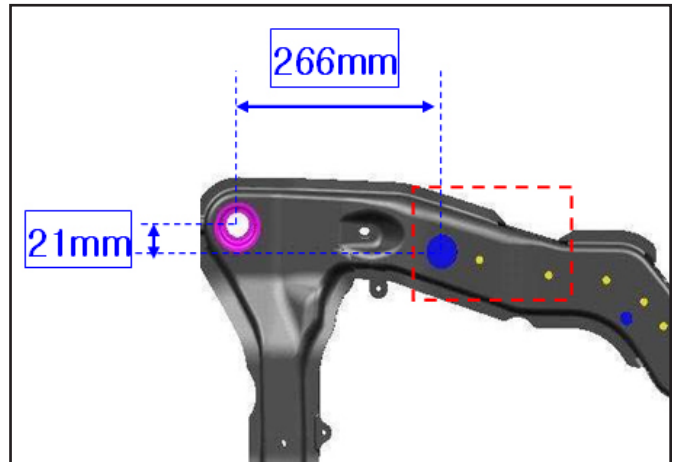

8. Place the LH and RH templates against the underside of the subframe, just parallel to the control arm with the arrows pointing forward. Align the outlines on the templates to the outboard shape of the subframe. Ensure proper orientation of the front (Frt) alignment of the templates for left/right. Use a grease pen to mark through the two holes on each template.

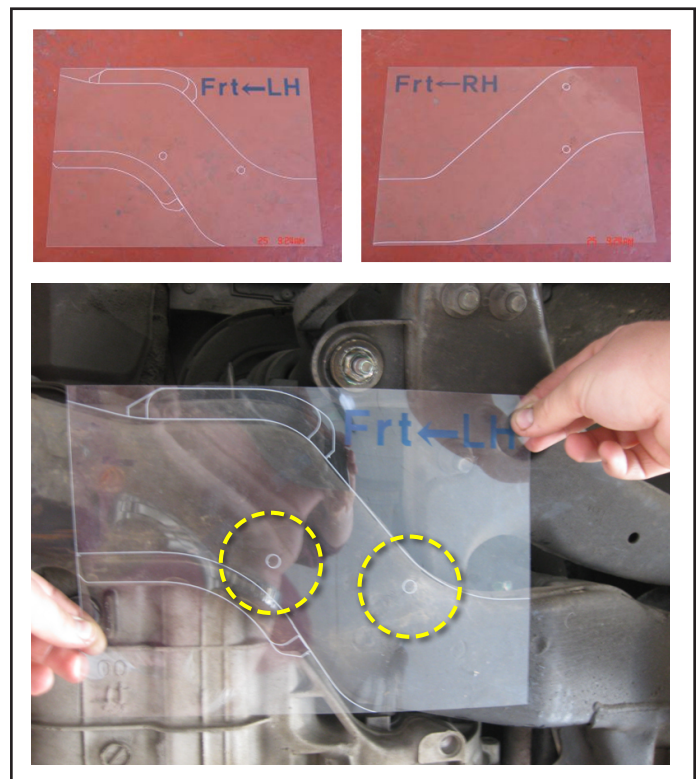
***NOTICE**

These holes will prevent any water which enters the subframe from becoming trapped.

SUBJECT:

REPAIR/REPLACEMENT OF SUBFRAME

9. Using an 8mm drill, drill four (4) holes in the locations marked in the previous step. Deburr all 8mm holes.

 **CAUTION**

Use safety glasses, respirator and gloves when performing any procedure using a drill.



10. Use the following procedures to remove as much of the rust fragments as possible from inside the subframe.

- a) Strike the underside of the subframe lightly with a hammer to cause vibration and dislodge any rust scale.

 **NOTICE**

Do not use excessive force near the edges of the 40 mm holes to prevent deformation in this area.



- b) Insert the magnetic pick up tool through each of the four 40mm holes and pull the magnet along in either direction as far as possible to remove any larger fragments.
- c) Insert air blow gun into each of the four 40mm & 8mm holes. Use shop air to blow as much of the rust particles as possible from inside the subframe. In some cases, if there is a large amount of loose rust scale present you may have to repeat the above steps another 2 to 3 times.



SUBJECT:

REPAIR/REPLACEMENT OF SUBFRAME

CAUTION

Use safety glasses and a respirator when performing this procedure to protect against any flying debris. For best results with wax injection gun, adjust air pressure to 90 ~ 120 psi. The wax working temperature range is 50 ~ 90 F°.

11. Pour one bottle of VG-101 Rust Preventive (Cavity Wax) into the wax injection container and connect the 90 degree nozzle assembly (shown). Spray the cavity wax into each of the four 40mm & 8mm holes and in all directions, dividing wax equally through each of 8 (eight) openings, using the entire bottle of cavity wax. You should begin to see some of the cavity wax draining from the four drain holes and other open areas of the subframe.

NOTICE

Make sure to use the entire bottle and attempt to coat as much of the inner surface area of the crossmember as possible.

After completing the cavity wax application, continue to blow shop air through the nozzle for a short time to clear any material from the nozzle.

Use a shop towel to clean any excess wax that has been sprayed onto the exterior portion of the subframe or is dripping from the drain holes.

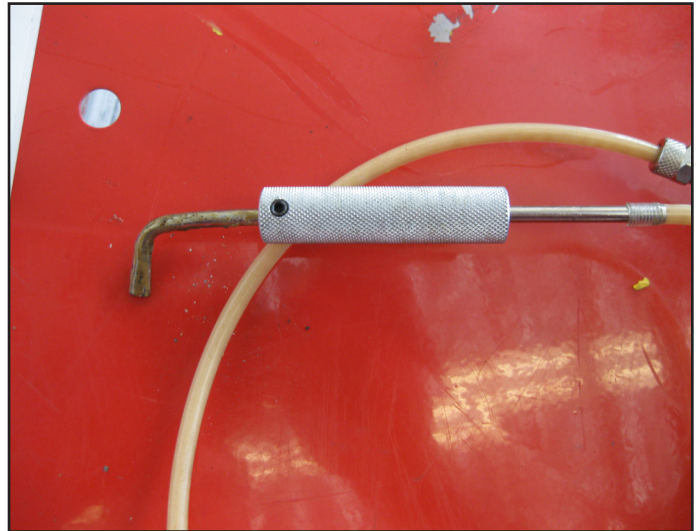

SUBJECT:

REPAIR/REPLACEMENT OF SUBFRAME

CAUTION

Wear safety glasses, a respirator and gloves when spraying the cavity wax.

Ensure that the work area is properly ventilated.

Be careful not to spray any wax onto neighboring parts or body panels.



12. Spray undercoating on the underside of the subframe near the four (4) 40 mm access holes and 8 mm drain holes. Do not spray the entire subframe with undercoating.



13. Cover all four (4) of the 40mm access holes with the hole plugs listed in the parts information section and apply a small amount of undercoating across the plugs.



SUBJECT:

REPAIR/REPLACEMENT OF SUBFRAME

14. Lower the vehicle, open the hood and install the SC075 completion label on the panel above the the master cylinder.



AFFECTED VEHICLE RANGE:





Optima (MS) in 21 states* in the USA and produced between 10/6/2000 ~ 11/19/2003

* *Maine, New Hampshire, Vermont, Massachusetts, Rhode Island, Connecticut, New York, New Jersey, Pennsylvania, Delaware, Michigan, Ohio, Indiana, Illinois, Wisconsin, Minnesota, Iowa, Missouri, Maryland, West Virginia, DC*

WARRANTY CLAIM INFORMATION:

Claim Type	Causal P/N	Qty.	N Code	C Code	Repair Description	Labor Op Code	Time	Replacement Parts	Qty.
R	62405 38300QK	0	N56	C05	Subframe inspection and Waxing	090013R0	0.7 M/H	62466 38000QK	4
		1			Subframe inspection and Replacement (With Drilling Hole)	090013R2	3.2 M/H	62405 38300QK	1



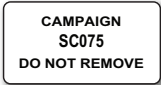



SUBJECT:**REPAIR/REPLACEMENT OF SUBFRAME****PARTS INFORMATION:**

Part Name	Part No.	Figure	Remark
Crossmember (Subframe) Assembly	62405-38300QQK		Only required in case of excessive corrosion (Initial shipment to dealers in states identified in this TSB, order additional as needed)
ValuGard Cavity Wax (Rust Preventive)	VG-101		2 included with initial shipment 1 ea. bottle required per vehicle [to order additional bottles, contact Snap-On Equipment Solutions at (888) 542-1011]
Undercoating	Generic		Purchased in local market. (Black color)
Hole Plug	62466-38000QQK		Order as required. TSB requires 4 per vehicle
Campaign Completion Sticker	UQ090 SC075		Order as needed.

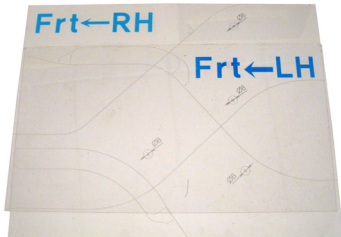
SUBJECT:

REPAIR/REPLACEMENT OF SUBFRAME

TOOLS INFORMATION:

Part Name	Part No.	Figure	Remark
Templates	1 Set provided, Print additional from copies attached to this TSB as required		Provided as part of SC 075 Campaign Kit. If additional templates are required, print copies attached to this TSB.
Wax Injection Gun	AU51933		Provided as part of SC 075 Campaign Kit. If replacement is necessary, order through Snap-On Equipment Solutions at (888) 542-1011
40mm Hole Saw	SC075-HOLESAW		
Thickness Gauge	SC075-GAUGE		
Magnetic Pick Up Tool	DPTM24		
Air Blow Gun	YA105020		

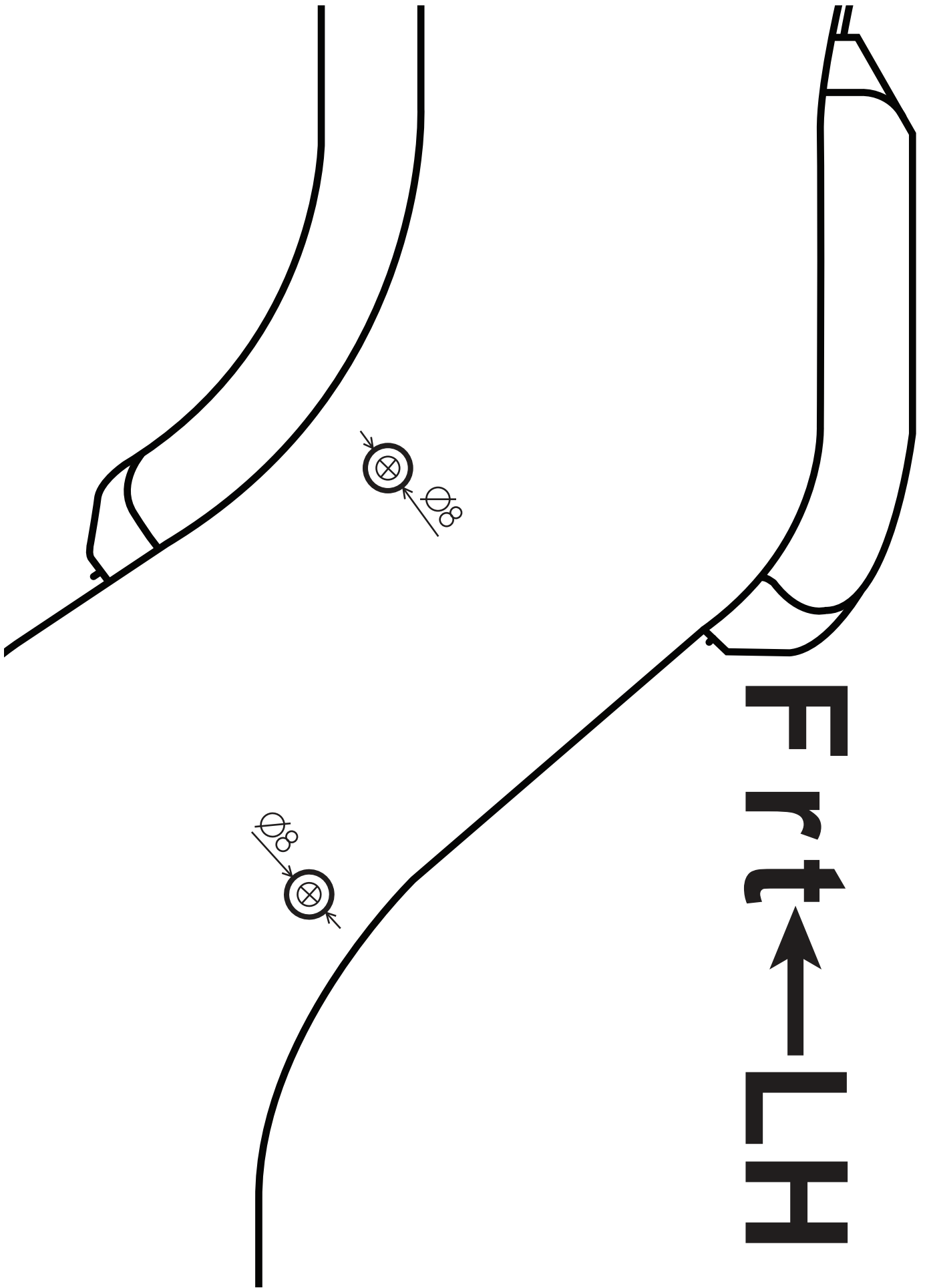

F r t ← U H

F r t ← R H

